

FOOT MASTER

G-DOK IND.

FOOT MASTER

G-DOK IND.

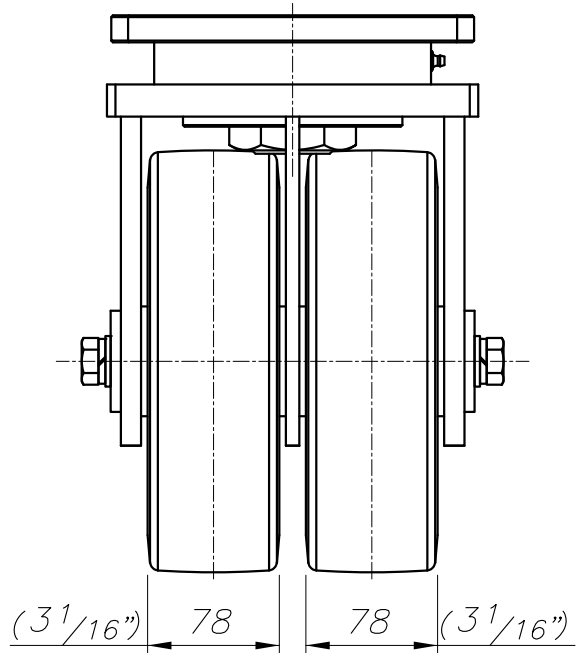
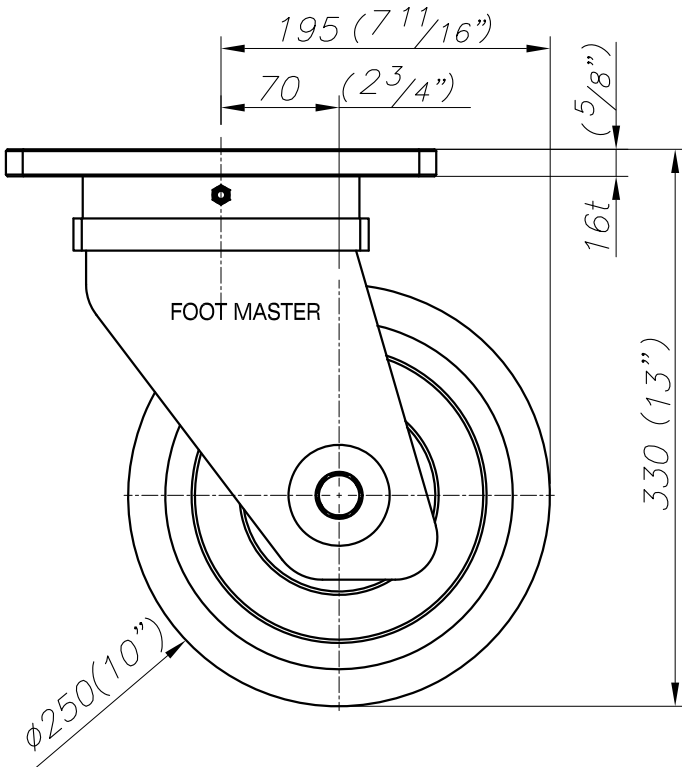
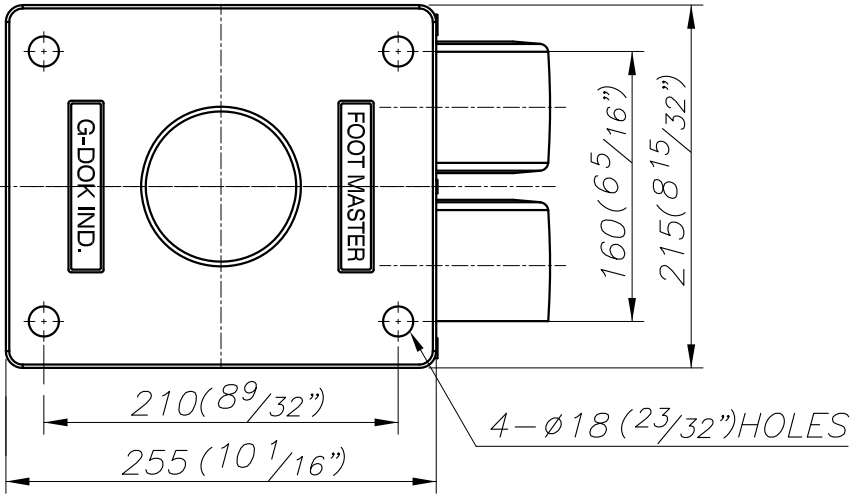

FOOT MASTER[®]

FOOMA[®]

G-DOK IND.

MODEL NAME

GXTD-250-ASF

A

B

C

E

F

G